

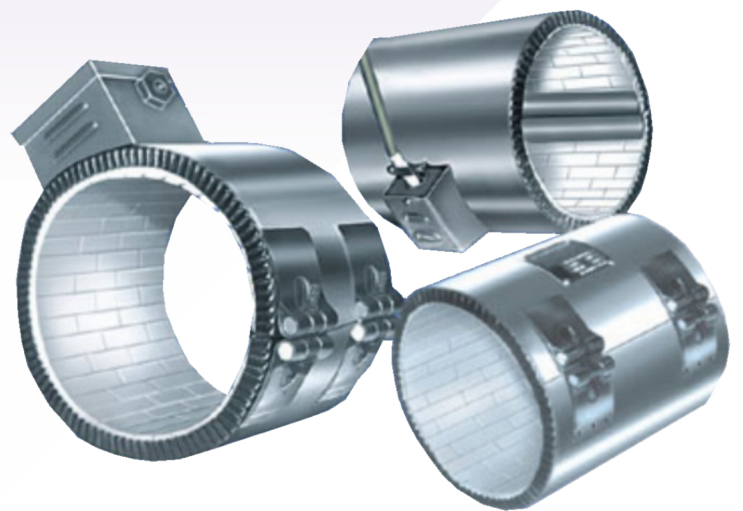

長新科技股份有限公司  
ARICO TECHNOLOGY CO., LTD.

# 陶瓷電熱片 Ceramic Band Heater



# 目錄 Contents



塑膠機械產品解決方案 Total solutions for plastic machine .....	03
產品總覽 Products overview .....	04
陶瓷電熱片 Ceramic band heater .....	06
保溫式陶瓷電熱片 Insulation plus ceramic band heater .....	07
氣冷式陶瓷電熱片 Air cooled ceramic band heaters .....	08
出線型式選項 Termination variations .....	09
固定方式選項 Clamping variations .....	10
微管線圈電熱片 Micro tubular coil heaters .....	12
陶瓷電熱片 Ceramic band heater .....	14
鑄黃銅電熱片 Coil heaters cast in brass .....	17
電熱線圈 Coil heaters .....	19
構形管狀電熱片 Formed tubular heaters .....	23
高瓦特密度長筒電熱片 High watt density cartridge heaters .....	25
雲母帶電熱片 Mica band heaters .....	27

# 長新科技塑膠機械產品解決方案

## ARICO TECHNOLOGY Total Solutions for Plastic Machine



桌上型電腦

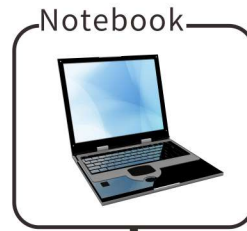

筆記型電腦

乙太網路  
Ethernet



射/押出機控制系統 Plastic Machine Controllers



固態繼電器  
Solid State Relays



溫度控制器  
Temperature Controllers



電熱調整器  
Heater Power Regulators



位移傳感器  
Displacement Transducers

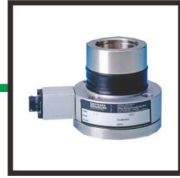

荷重元 Load Cells



壓力傳感器  
Pressure Transducers



耐高溫高壓熔體壓力計  
Melt Pressure Transducers



變頻器 Inverters



指示警報器  
Indicators/Alarm units



壓力控制器  
Pressure Controllers



熱澆道溫度控制器  
Hot Runner  
Temperature Controllers

MODBUS





















































MODBUS

# 產品總覽 (Products Overview)

義大利 GEFRAN 公司及其它代理產品 Agent products

壓力傳感器 Pressure Transducers																				
	K3 Series		KE Series		KN Series															
	M3 Series		ME Series		MN Series															
	M5 Series		M6 Series		KS/TK															
位移傳感器 Displacement Transducers																				
	LT/LT67/LTC		PC		PK		PA1		PY1/PY2/PY3											
	PZ12/PZ34		PC67/PZ67A/PZ67S		PMA12/PME12/PMI12		PMI-SL/PMI-SLE													
	IC		PR65		PS		PCIR													
	WPG-A			WPP/WPA Series			WRP/WRA/WRG Series													
溫度/壓力/顯示/警示 控制儀表 Controller/Alarm unit/ Programmer/Indicator																				
	4T48		4T96		40TB		40B96		400-401		450		600		650		2400		2500	
功率控制器/固態繼電器 Power Controller/ Solid State Relay																				
	GRM-H		GRP		GRP-H		GRS		GRS-H		GRZ		GRZ-H		GQ					
陶瓷電熱片 Ceramic Band Heater																				
	一般式 Ceramic Band Heater			保溫式 Insulation Plus Ceramic Band Heater						氣冷式 Air Cooled Ceramic Band Heater										

# 產品總覽 (Products Overview)

溫度控制器 Temperature Controllers V Series							
	V100	V200	V300	V400	V500		
溫度控制器 Temperature Controllers C Series							
	C100	C200	C300	C400	C500		
溫度控制器 Temperature Controllers A Series							
							
	A3DA	A3DD	A4AA	A4AD	A4AN	A4DA	A4DD
溫度控制器 Temperature Controllers TC Series							
							
	TC3DO	TC4AA	TC4AO	TC4DA	TC4DO		
熱澆道溫度控制器 Hot Runner Temperature Controllers							
			TC500	TC5T	TC5H	TC5E	
							
			TC50	閥門控制器 Valve Gate Controller	TC5V		
橡塑膠機控制系統 (射出機/押出機/吹瓶機等...) Plastic Machine Controllers							
	AR800/AR810/AR1280/AR2000/AR2010/AR2100			AR/FT Series - HMI			
固態繼電器 Solid State Relay							
	ARD24 Series	ARD48 Series	SY Series	SV Series	SW Series		
電熱調整器 Heatsoft			訊號轉換器 Signal Transmitter				
	SB Series			TR100/TR200			

# 陶瓷電熱片 Ceramic Band Heater

## 產品介紹 Introduction

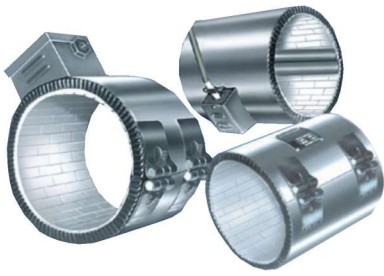

陶瓷電熱片是為了工業界在工程塑膠方面的需要而開發，能高溫耐久的電熱片，適合應用在新樹脂材料，可以應付不斷提昇的加工溫度。

陶瓷電熱片是以 80/20 鎳鉻線電阻線圈螺旋繞法製造而成的，可以平均地伸展及串接起來，穿越製作精良的陶瓷隔板而成電熱片。

陶瓷電熱片和纖維一同放在鋸齒狀的不銹鋼套中，具有良好的可繞性，便於安裝。

Ceramic Band Heaters were developed to meet industrial requirements for high temperature long lasting heaters. They are ideally suited to comply with today's new resins, which calls for ever-increasing process temperatures.

Ceramic Band Heaters design consist at a helically wound resistance coil made from 80/20 nichrome wire, evenly stretched and precisely strung through a specially designed ceramic insulation bricks forming a flexible heating mat.

The ceramic heating mat along with ceramic fiber insulation is placed on a stainless steel housing made with serrated edges providing maximum flexibility for easy installation.

## 標準特色 Standard Features

- |                      |   |
|----------------------|---|
| 1. 隔熱性佳              | 1. Thermal insulation                           |
| 2. 節省能源              | 2. Conserves energy                             |
| 3. 熱損失極小             | 3. Minimum heat loss                            |
| 4. 安裝方便              | 4. Easy installation                            |
| 5. 加熱均勻              | 5. Uniform temperature                          |
| 6. 壽命加長              | 6. Better heater life                           |
| 7. 可接受客製規格           | 7. Can be manufactured to your specification    |
| 8. 可按需要製造多種類型的構造和出線端 | 8. Various types of construction & terminations |

## 應用 Applications

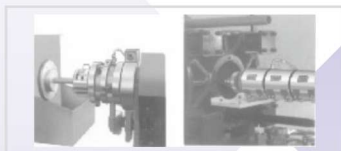

押出機

射出單元

## 技術規格 Technical Specifications

阻抗 Resistance	+10%, -5%
瓦數 Wattage	+5%, -10%
最大功率密度 Max. Watt Density	8 watts/sq. cm.
電壓 Voltage	220 Vac to 480 Vac
最高溫度 Maximum Temp.	800°C
厚度 Thickness	15 mm
最小直徑 Minimum Diameter	38 mm
最小寬度 Minimum Width	25 mm
一般寬度 Nominal Width	Multiple of 15 + 6 mm
間隙寬度 Gap Between Edges	5 ~ 10 mm

# 保溫式陶瓷電熱片

節省能源  
Save Energy  
30%



## Insulation Plus Ceramic Band Heater

### 產品介紹 Introduction

保溫式陶瓷電熱片的設計和製造是為了回應在能源節省及操作效率方面不斷增進的要求。

為有效的節省能源，我們使用 1" 厚的粗陶器纖維絕熱罩罩在外表面，增加所有外表的直徑 2" (最低長度是 4")。由於低的熱導系數，這層陶瓷纖維可降低 30% 的耗電量。當內部溫度達到 300°C 時，其外表的溫度大約只有 80°C。

The Heaters are specifically designed and engineered to meet the ever increasing demand for energy conservation and to improve operation efficiency capable of generating higher temperature. Energy conservation is achieved by using 1" thick ceramic fiber insulating blanket on the outer surface increasing the overall outer diameter by 2" (Min. length required is 4"). Reducing power consumption up to 30%. Because of low thermal conductivity of the ceramic fiber insulation, the external surface temperature is approximately 80°C while running the inside surface temperature at 300°C

### 標準特色 Standard Features

1. 節省能源在 30% 以上
  2. 電熱片可以降低瓦特數
  3. 使加熱更均勻
  4. 減少加熱時間提高生產力
  5. 有效減低機械的預熱時間
  6. 短時間內即可回收電熱片成本
  7. 大幅降低環境溫度，使工作環境更舒適
1. Saving in energy up to 30%
  2. Reduced wattage of heater
  3. More uniform heating
  4. Less down time increases productivity
  5. Reduced preheating time of machine
  6. Heater cost is recovered in shorter time
  7. Cool working atmosphere for operator

### 技術規格 Technical Specifications

阻抗 Resistance	+10%, -5%
瓦數 Wattage	+5%, -10%
最大功率密度 Max. Watt Density	8 watts/sq. cm.
電壓 Voltage	220 Vac to 480 Vac
最高溫度 Maximum Temp.	800°C
厚度 Thickness	40 mm
最小直徑 Minimum Diameter	50 mm
最小寬度 Minimum Width	100 mm
一般寬度 Nominal Width	Multiple of 15 + 6 mm
間隙寬度 Gap Between Edges	5 ~ 10 mm

# 氣冷式陶瓷電熱片

## Air Cooled Ceramic Band Heater

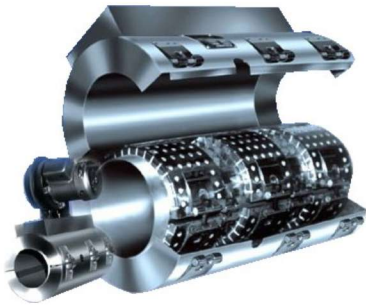

### 產品介紹 Introduction

氣冷式陶瓷電熱片應用為押出機和吹瓶機，提供極佳加熱效率及冷卻能力。

電熱片以穿孔金屬板形式製作，有 60% 開孔面積保證有最大表面積進行冷卻。在電熱片上加上鼓風機蓋是為了放置在鼓風機上。其氣冷式操作優於液冷式，特別是低廉的花費、方便的更換、簡易的維護，沒有洩漏的問題及溫度控制均勻等優點。

Air cooled Ceramic Band Heaters are designed for super ancient and economical cooling on extrusion and blow molding machines. Heater band is 60% open by perforated metal sheet which ensures maximum surface exposure for better cooling.

The heater band is covered with blower cover for mounting the blower. Advantages of air cooled over liquid cooled operation includes lower cost, easy replacement, low maintenance, no leakage problem and uniform temperature control.

### 標準特色 Standard Features

- |   |  |
|---|--|
| <ol style="list-style-type: none"><li>1. 電熱/冷卻一體成型之模組化設計</li><li>2. 低廉的維護費用</li><li>3. 方便的零件更換</li><li>4. 產品品質提升</li><li>5. 空間的節省</li><li>6. 生產力的增加</li><li>7. 接受客戶訂製<br/>直徑、長度、電壓、瓦特數和結構可供選擇</li></ol> | <ol style="list-style-type: none"><li>1. To heat and cool the barrel</li><li>2. Low maintenance</li><li>3. Easy replacement</li><li>4. Improves quality of finished products</li><li>5. Space saving</li><li>6. Increases productivity</li><li>7. Available with various diameter, length, voltage, wattage and configurations</li></ol> |
|---|--|

### 應用 Applications

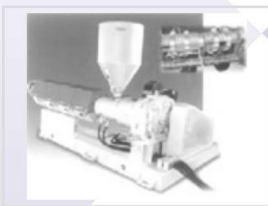

押出機上的氣冷式陶瓷電熱片

### 選配 Optional Feature

穿孔加熱器鰭片提供更快的冷卻  
Perforated heater with fins to provide faster cooling



# 出線型式選項 Termination Variations

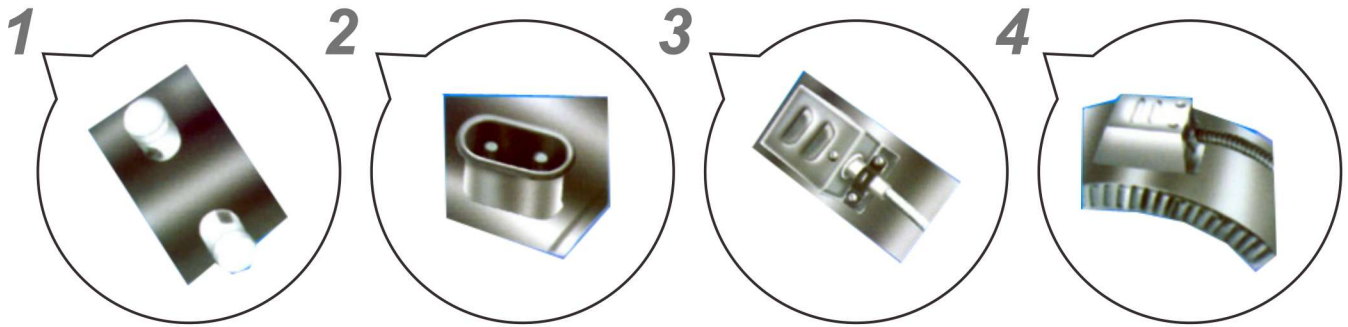

## 1 螺絲型：CL

### Ceramic terminal cover on post terminals type: CL

螺絲型提供方便的連接方式，陶瓷覆蓋可以和螺絲型出線端鎖緊。提供方便、經濟的絕緣，可用於 40 mm 或更長的電熱片。

Post terminals provide optimum connection. Ceramic covers with openings for leads are screwed onto post terminals providing a convenient, economical insulator.

Can be provided on heater length 40 mm or more.

## 2 插頭型：PL

### High temperature “quick disconnect” plugs type: PL

本型提供最簡單、快速的方法使電熱片得到能源，沒有暴露的出線端或電線，可以大幅降低潛在的工安危險，可用於 40 mm 長的電熱片或更長，建議電熱片的容量不要超過 2.5 KW。

This provide the simplest and fastest way to apply power to band heaters. This assembly eliminates all live exposed terminals and electrical wiring that can be potential hazard to employees or machine. Can be provided on heater length 40 mm or more.

Recommended for heater capacity up to 2.5 KW.

## 3 金屬盒出線型：ST

### Metallic terminal box connection type: ST

貼附於電熱片的金屬盒，在末端有安全的覆蓋。可用於 40 mm 或更長的電熱片。

Metallic terminal boxes that attach directly to the heater act as a safety feature by covering the terminals. Can be provided on heater of length 40 mm or more.

## 4 防油防水導管連接型：STC

### Conduit pipe connection type: STC

靈活的不銹鋼導管能充分保護玻璃纖維隔離導線，可用於 40 mm 或更長的電熱片。

Stainless steel flexible conduit pipe work as a protector for fiberglass insulated lead wires.

Can be provided on heater of length 40 mm or more.

# 固定方式選項 Clamping Variations

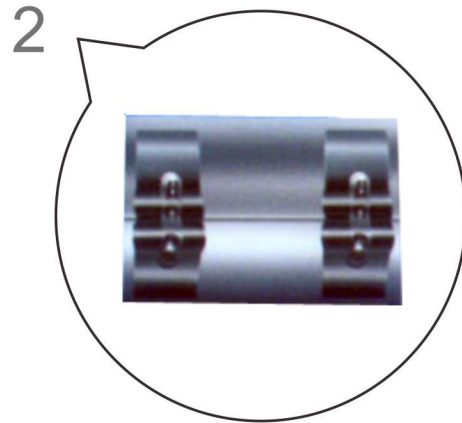
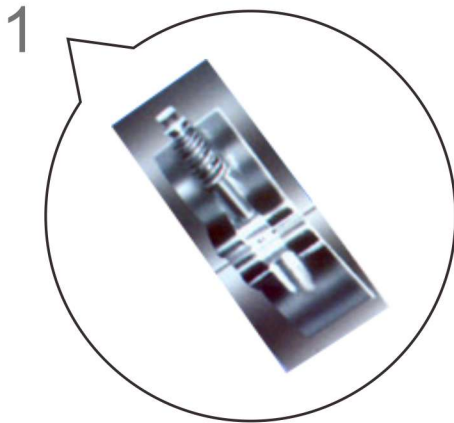

## 產品介紹 Introduction

### 1. 彈簧加壓固定型：ABS

鎖門和彈簧加壓固定型提供電熱片良好的固定  
電熱片因熱脹冷縮引起破裂。

### 2. 標準鎖門固定型：AB

鎖門和標準固定型可用於全部的電熱片。

### 1. Spring loaded clamping type: ABS

Allen bolt with spring loaded clamping system provides excellent grip of the heater mounted vertically. Recommended in all die heaters.

### 2. Standard Allen Bolt clamping type: AB

Allen bolt with standard clamping system generally used on all heaters.

## 規格和公差 Specification and Tolerances

阻抗：+10% -5%  
瓦數：+5% -10%  
最大功率密度：8 watts/sq. cm.  
電壓：220 Vac ~ 480 Vac  
最高溫度：800°C

Resistance: +10% -5%  
Wattage: +5% -10%  
Max. Watt Density: 8 watts/ sq. cm.  
Voltage: 220 Vac ~ 480 Vac  
Maximum Temp.: 800°C

全尺寸  
標準開度：15 mm  
最小直徑：38 mm  
最小寬度：25 mm  
一般寬度：15的倍數 + 6 mm  
間隙寬度：5 ~ 10 mm

Overall Thickness  
With Standard Insulation: 15 mm  
Minimum Diameter: 38 mm  
Minimum Width: 25 mm  
Nominal Width: multiple of 15 + 6 mm  
Gap Between Edges: 5 ~ 10 mm

## 安裝與維護建議 Installation & Maintenance Recommendations

1. 陶瓷電熱片是非常靈活的，而且可用較大的寬度一體成型，具有安裝容易、減少陶瓷帶來的熱損失和人工安裝成本降低的效益。
2. 安裝前與操作時，請將料管表面和電熱片徹底擦拭乾淨。因料管表面或電熱片上若有油污或其他不明之液態污染物，將會滲入陶瓷電熱片內，在加熱後那些不明物質會碳化，而碳化物會造成陶瓷電熱片內之電線短路，而導致陶瓷電熱片損壞。  
※主意：安裝電熱片時，請勿上油，以防短路。
3. 在固定陶瓷電熱片請不要將其鎖太緊；固定時只要將螺絲鎖好至陶瓷電熱片在料管上用手去推而推不動的力道便可。絕對不可以鎖太緊，因鎖太緊會導致陶瓷電熱片上之陶瓷碎裂。陶瓷電熱片在加熱後會自然膨脹而去抓緊料管，所以會有很好的接觸面。因此不用像鎖傳統雲母電熱片那樣鎖得非常緊，只需含住即可。
4. 為防止過熱或電熱片失效，應該安裝適合的溫度控制器，感溫線一定避免污染和檢查溫度改變的反應，壞的感溫線有可能造成整個加熱區域設備的毀壞。
5. 請參照陶瓷電熱片上之電壓規格配電。
6. 在電熱片沒有斷電前，不要進行任何維修工作。
7. 錯誤接線是電熱片燒壞的普遍原因。請讓合格人員進行電熱片的電源接線。
8. 維護機器時，請小心避免被陶瓷電熱片表面溫度燙傷。

1. Ceramic Band Heaters are very flexible and can be made in large widths and one piece construction for easy installation eliminating heat losses between narrow bands and sharply reducing labor cost in installation.
2. Before installation & during operation, the surface of the barrel and ceramic band heater must be clean and free from all contaminants that might liquefy under heat and find their way into the heater elements, carbonizing and becoming conductive. The smallest amount of contamination can cause electrical shorts creating heater failure.
3. Tighten the allen bolt until the serrated edges become firmly in direct contact with the barrel to get the uniform contact. Do not over tighten, as to the point where serrated edges begin to collapse and thrust outwards. Unlike all other types of band heaters, ceramic heater works on conduction and radiation principle and they do not require the same clamping force essential on all other types of band heaters.
4. To prevent the overheating and heater failure, adequate temperature controllers should be installed. Thermocouples must be kept free of contaminants and checked for good response to temperature changes. A bad thermocouple can be the cause of destroying an entire heating zone.
5. Keep all electrical connections properly protected to avoid accident.
6. Never perform any type of service on heaters without disconnection all electrical power.
7. Incorrect wiring is a common cause in heater burn out.
8. Qualified person should do electrical wiring of heaters.

## 訂購資訊 Ordering Information

- |                                  |   |
|----------------------------------|---|
| 1. 內徑 (n)                        | 1. Inside diameter (n)  |
| 2. 電熱片的長度 (L)                    | 2. Length of the heater (L)   |
| 3. 電壓                            | 3. Operating voltage  |
| 4. 瓦特數                           | 4. Wattage  |
| 5. 電熱片的 T/C 和狹縫上工作孔的位置大小 (假如有的話) | 5. Location dimensions of holes for T/C and slots in the heater (If any)    |
| 6. 出線端的類型和位置                     | 6. Termination type and location  |
| 7. 出線長度                          | 7. Lead length  |
| 8. 數量                            | 8. Quantity   |
| 9. 訂購產品請詳述印在電熱片上的訂購碼             | 9. In case of repeat order please specify Code no. as punched on the heater |

# 微管線圈電熱片 Micro Tubular Coil Heaters



## 產品介紹 Introduction

微管線圈電熱片有兩個標準直徑，2.4 mm 及 1.9 mm (0.094" 及 0.071")。這些電熱片均加以鍛造和緊壓，符合直徑，然後套入特製的固定型式，以緊握於圓形零件上，供加熱之用。

Micro Tubular Coil Heaters are manufactured in two standard diameters, 2.4 mm and 1.9 mm (0.094" & 0.071"). These heaters are swaged and compacted to these diameters and fitted into special clamps to tighten over circular parts for heating purpose.

## 螺旋固定 Screw Clamp

直徑 2.4 mm 的微型管狀電熱片，形狀 (0.094" 及 0.071")。這些電熱片均加以鍛造和緊壓，符合直徑，然後套入特製的固定型式，以緊握於圓形零件上，供加熱之用。

是緊彎成圓圈的線圈，且套上螺旋固定帶，使其裝配於加熱零件的效果更為緊密。這些電熱片以 304 不銹鋼套及外部固定製成。較大的截面積 (2.4 mm) 使它具有較佳的電力特性。我們提供標準尺寸的電熱片，具有冷鍛的導線，長度為 5" 及 7"。J 和 K 型的感溫線可應要求納入外部護套。

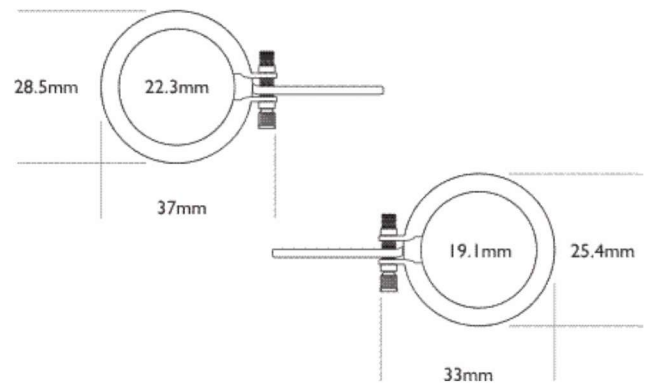

The 2.4 mm diameter Micro Tubular Heater is formed into a tightly wound coil and wrapped around with a Screw Clamping Band for better and tighter fit over the part to be heated. These heaters are manufactured with a 304 Stainless Steel sheath and outer clamp. A larger cross section area (2.4 mm) gives it better electrical properties. We offer these heaters in standard sizes with a staggered cold lead length of 5", 7" and "J" or "K" thermocouple can be incorporated on the outer sheath upon request.

## 直徑 2.4 mm 之現有庫存標準電熱片 Standard Ready Stock Heaters of Ø 2.4 mm

導線為 18 ga 銀鍍銅，並以鐵弗龍絕緣。  
電流及電阻誤差 ± 5%  
固定螺絲大小：M3 × 15 mm (包括螺絲頭)

Lead wires are 18 ga Silver coated copper and Teflon insulated.  
Watts and Resistance Tolerance ± 5%  
Clamp Allen Screw Size: M3 × 15 mm (Including the head)

伏特 Volts	瓦特 Watts	內部直徑 Inner Diameter	外部直徑 Outer Diameter	寬度 Width	導線 Lead Wire	零件編號 Part no.
240	268	19.1	25.4	30.5 mm	1800 mm (72")	SC24192
240	149	19.1	25.4	30.5 mm	1800 mm (72")	SC24191
240	268	22.2	28.5	30.5 mm	1800 mm (72")	SC24222

## 軸心固定 Axial Clamp

直徑 1.9 mm 的微管線圈電熱片形狀是圓圈，且配有特製的蓋子，裝配容易。這種名為軸心固定的特製蓋子可容許前端的荷重及可調整性。

好的操控性可容許電熱片在多模穴模具使用時減少停機時間。這些電熱片配有 5" 和 7" 的冷鍛導線。

The 1.9 mm diameter Micro Tubular Heater is formed into a coil of predefined dimension and equipped with a special cover for easy fitment. This special cover called Axial clamp allows front end loading and adjustability.

Such easy handling saves hours of downtime in case of heater failure in a Multi-Cavity mold. These heaters are offered with staggered cold leads of 5" & 7".

## 直徑 1.9 mm 之現有庫存標準電熱片 Standard Ready Stock Heaters of Ø 1.9 mm

導線為 18ga 銀鍍銅，並以鐵弗龍絕緣。

電流及電阻誤差 ± 5%

固定螺絲大小：M3 × 15 mm (包括螺絲頭)

Lead wires are 18ga Silver coated copper and Teflon insulated.

Watts and Resistance Tolerance ± 5%

Clamp Allen Screw Size: M3 × 15 mm (Including the head)

伏特 Volts	瓦特 Watts	內部直徑 Inner Diameter	寬度 Width	導線 Lead Wire	零件編號 Part no.
240	268	19.1	30.5 mm	1800 mm (72")	SC24192
240	149	19.1	30.5 mm	1800 mm (72")	SC24191

若欲縮短加熱時間，本公司可提供具有截面積 1.4 mm × 2.2 mm 的類似電熱片。

冷導線直徑為 1.9 mm，而電熱片具有平坦的截面，擁有較佳的接觸面積，傳熱較快。

可提供使用的標準尺寸如下：

For faster heat up time we can offer similar heaters with a flat cross section of 1.4 mm × 2.2 mm. The cold leads have a diameter of 1.9 mm whereas the heated area has a flat cross section for better contact area and faster heat transfer. Standard sizes available are mentioned below.

伏特 Volts	瓦特 Watts	內部直徑 Inner Diameter	寬度 Width	導線 Lead Wire	截面積 Cross Section	零件編號 Part no.
240	268	19.1	30.5 mm	1800 mm (72")	1.4 × 2.2	SC24192
240	149	19.1	30.5 mm	1800 mm (72")	1.4 × 2.2	SC24191

## 注意事項及安裝 Precautions & Installation

1. 微型管狀熱器因含氧化鎂，吸濕性質，若較長時間不使用，則終端將會潮溼。因此建議您於安裝前置於爐上以 100°C 加溫除濕持續約 1 ~ 2 小時，或使用具有軟啟動功能的控制器。如此有助於蒸發任何內部的潮溼。
2. 將微型管狀電熱片安裝至管嘴時，應當小心，將電熱片能安裝緊牢，使熱能均勻分佈。切勿以扭轉方式打開 ID，以免裝配不夠緊牢，造成電熱片過早失效。
3. 由於每立方公分的高電量密度，微型管狀電熱片需要精確的溫度控制器。PHP 建議使用品質優良的軟啟動功能的熱澆道控制器。
4. 導線末端 (非加熱) 若已彎曲，不應再度彎曲。應避開沿著導線線路徑的鋒利邊緣。連結導線的部位應予以保護，以免接觸可燃燒的氣體及液體，以避免短路。
5. 轉接器部位應維持 100°C 以下的溫度 (電熱片與導線之間的接合)
6. 穩定之電壓供應可增加電熱片之壽命，並增加電流輸出。

1. Micro tubular Heaters are hygroscopic in nature due to MgO contents. If kept unused for longer period, there is moisture deposition on the terminals. Therefore we recommend you to de-moisturize the heaters prior to installation by heating them at 100°C in an oven for Approximately 1 to 2 hours or use controllers with soft start function. This will help evaporate any moisture present inside.
2. While installing Micro tubular Heaters on to the nozzle care should be taken that they should be tight fit for even heat transfer. There should not be air gaps between the heater and the nozzle. Never open the ID of the heater by twisting as it will not fit tight which leads to premature heater failure.
3. Due to high watt densities per cm/sq, Micro tubular Heaters require precise temperature controllers, PHP strongly recommends to use good quality soft start Hot Runner Controllers.
4. Lead ends (Non Heating) once bent should not be re-bent. This could lead to breakage. Sharp edges along the lead wire path should be avoided. Connection lead areas should be protected from combustible gases & liquid to avoid short circuits.

# 陶瓷電熱片 Ceramic Band Heater

## 產品應用 Introduction

射出成型、中空成型、押出機、包裝工業、實驗室器材、製鞋工業、橡膠工業及各種其它塑膠處理機械。

Injection molding, Blow molding, Extruders, Packaging industry, Laboratory equipment, Shoe industry, Rubber industry, and various other plastic processing machinery.

## 技術規格 Technical Specifications

1. 鋼製的接線盒 (見次頁) 為曝露在外的出線端提供良好的保護。為簡化電線的裝配，此接線盒具有彈性的線材接頭。鋼製的螺絲出線端與堅硬的鎳針棒連接。針棒可提供最大的電流攜帶能力。
2. 所有厚度 1/8" 的電熱片上配有標準的內建熱能節省隔熱片，可減少功率消耗。
3. 特製的安裝托架，配有 M-6 × 45 mm 圓柱頭螺絲，用於將加熱組件均勻緊密貼靠在滾筒上，此滾筒位置距離螺絲出線端 180C。
4. 螺旋捲曲的鎳鉻電阻線串連了特製的陶瓷隔熱磚。
5. 不銹鋼的外殼具有鋸齒狀的邊緣提供最大的彈性，以便隔熱。
6. 為避免組件的汙染且使熱能均勻轉移至滾筒上，若有需要，可提供特別設計的內部金屬護套。

1. A Steel terminal box (See overleaf) offers excellent protection to exposed terminals. To simplify electrical wiring, the box has flexible cable connectors. Steel screw terminals connected to solid nickel pins are designed to provide maximum amperage carrying capacity.
2. Built-In heat-saving insulation standard on all Ceramic Bands 1/8" thick will reduce power consumption. Further reduction can be obtained with higher thickness insulation.
3. Especially designed mounting brackets with M-6 × 45 mm socket cap screw is used to securely draw the heating element assembly against the cylinder evenly & tightly across its entire width, located at 180C from the screw terminals.
4. Helically wound Nickel-Chrome resistance wire strung through specially designed ceramic insulation bricks.
5. Stainless Steel housing with serrated edges provides maximum flexibility for ease of insulation.
6. To avoid contamination with the element & also provide even heat transfer onto the cylinders, a specially designed inner metal sheath casing can be provided if required.

## 技術資料 Technical Data

護套材料 : SS304  
隔熱材料 : 陶瓷隔熱片 (高溫)  
熱能節省隔熱片 : 1/8" 厚陶瓷纖維 (標準)  
加熱組件 : NiCr 60 : 16, NiCr 80 : 20  
名義壁厚度: 1/2" (標準); 配有額外之隔熱套 : 7/8"  
連結線 : 玻璃纖維/金屬等  
電壓範圍 : 110 V ~ 440 V  
表面負載 : 45 ~ 50 W/In (視應用而定)  
功率等級 : 視應用而定  
功率誤差 : ± 10%  
HV測試 : 加熱組件與套殼間為1.5KV  
隔熱電阻 (冷) : < 20 M Ohms  
護套溫度 : 可達攝氏 650 度 (不銹鋼護套)

Sheath material: SS304  
Insulation Material: Ceramic Insulators (High Temperature)  
Heat Saving Insulation: 1/8" Thick Ceramic Fiber (Std.)  
Heating Elements: NiCr 60 : 16, NiCr 80 : 20  
Nominal Wall Thickness: 1/2" (Std.); with extra Insulation Jacket: 7/8"  
Connection: Fiber Glass Braided/Metal Braided/Flexible Conduit (Std. 12" long) mounted on rigid screw post terminals  
Voltage Range: 110 V ~ 440 V  
Surface Loading: 45 ~ 50 W/In (Depending upon application)  
Power Rating: Depending upon application  
Power Tolerance: ± 10%  
HV Testing: 1.5KV between heating element and sheath  
Insulation Resistance (Cold): < 20M Ohms  
Sheath Temperature: Up to 650°C maximum (SS sheath)

## 標準結構 Standard Construction

- |   |   |
|---|---|
| <ol style="list-style-type: none"><li>1. 附 M-6 Allen Key Bolts (長度 45 mm)</li><li>2. 1/8 英寸熱能節省隔熱片</li><li>3. 位於寬度 90 處之鋼質螺絲出線端<br/>限制：最小 ID. 2.5" 最小寬度 1 ½"<br/>最大 ID. 21"</li></ol> | <ol style="list-style-type: none"><li>1. With M-6 Allen key bolts (45 mm long)</li><li>2. 1/8 Inch heat saving insulation</li><li>3. Steel Screw Terminals located at 90 of the width<br/>LIMITATIONS: Min. ID. 2.5" Min. Width 1 ½"<br/>Max. ID. 21"</li></ol> |
|---|---|

## 雙片結構 Two Piece Construction

- |  |   |
|--|---|
| <ol style="list-style-type: none"><li>1. 可用於任何螺絲及導線出線端或固定型式</li><li>2. 雙片式的電熱片通常以總瓦特數及完整伏特數的半數測量<br/>限制：最小 ID. 4" 最小寬度 1 ½"<br/>最大 ID. 24" - 2 片以上，最多可達 44 片</li></ol> | <ol style="list-style-type: none"><li>1. Available on any screw and lead termination or clamping variation</li><li>2. Two piece band heaters are normally rated at half the total wattage &amp; full line voltage<br/>LIMITATIONS: Min. ID. 4" Min. Width 1 ½"<br/>Max. ID. 24" - More than 2 pieces up to 44</li></ol> |
|--|---|

## 注意事項及安裝 Precautions & Installation

1. 減少狹窄或兩片式隔熱片的用量。陶瓷電熱片非常有彈性且可採用大的寬度及單片式的結構，以便安裝，消除狹窄隔熱片之間的熱能流失，並大幅降低昂貴的安裝成本。
2. 所計算之瓦特數應盡量接近操作的瓦特數，以減少開閉的循環。
3. 當以 PHP 陶瓷電熱片更換任何其他類型的非隔熱型電熱片時，您可將總操作瓦特數減少大約百分之 25%。
4. 為防止過熱及加電熱片失效，應安裝足夠的溫度控制器。務必防止感溫線遭汙染，且檢查其能否對溫度改變具有良好反應。
5. 避免將電熱片用於含有可燃燒液體或蒸氣的環境中。
6. 安裝前，滾筒的表面應清潔且沒有汙染。操作時，電熱片及滾筒表面必須完全沒有遇熱可能會液化並且進入電線、碳化及變成具有傳導性的汙染物。
7. 將低處的熱擴張外殼上緊直至鋸齒狀的邊緣與滾筒直接牢固接合。可使用皮質的錘子輪敲外部的邊緣，以達到均衡的接觸。當您將夾鉗螺絲上緊時，切勿過度上緊，以免造成鋸齒邊緣開始崩潰且向外插出。在此情況下，您已壓縮陶瓷隔熱片並減少其隔熱值。
8. 所有電力接點應予以適當保護，避免對機器操作者造成電力的危險。曝露的零件係直接違反電力安全規範。
9. 將所有電力拔除之前，絕不對電熱片進行任何類型的維修。
10. 電熱片或任何類型的電熱片上的電線配置應由遵守當地電力規範的合格人員進行。錯誤的配線是電熱片燒壞的常見原因。

1. Reduce the amount of narrow or two piece bands, Ceramic Bands are very flexible & can be made in large widths and one piece construction for easy installation, eliminating heat losses between narrow bands & sharply reducing costly labour in installation.
2. Calculated wattage should be as close as possible to operating wattage to minimize on-off cycling.
3. When replacing any other type of non-insulated band heater with PHP Ceramic Band Heaters, you can decrease your total operating wattage by approximately 25%.
4. To prevent overheating & heater failure, adequate temperature controls should be installed. Thermocouples must be kept free of contaminations and checked for good response to temperature changes. A bad thermocouple can be the cause for destroying an entire heating zone. For selecting temperature controls and thermocouples, PHP offers technical assistance for best results.
5. Avoid using heaters in an atmosphere containing combustible gases or vapours.
6. Prior to installation, the surface of the cylinder must be clean and free of all contamination. During operation, the band heaters and cylinder surfaces must be kept free of all contamination that might liquefy under heat and find their way into the windings, carbonizing and becoming conductive. The least amount of contamination can cause electrical shorts, creating heater failure.
7. Take up all the slack by tightening the low thermal expansion outer housing until the serrated edges become firmly in direct contact with the cylinder. A raw hide mallet can be used to lightly tap the outer edges only to get uniform contact. As you tighten the clamping screw do not over tighten, as to the point where the serrated edges begin to collapse and thrust outwards. At this point, you are compressing the ceramic insulation & decreasing its insulation values.
8. Keep all electrical connections properly protected to avoid electrical hazards to machine operators. Exposed live parts are in direct violation of safety electrical codes.
9. Never perform any type of service on heaters prior to disconnecting all electrical power.
10. Electrical wiring on band heaters or any other type of heaters should be done by a qualified person complying with local electrical codes. Incorrect wiring is common cause in heater burn-out.

## 訂購方法 How to order

請註明：內徑、寬度、瓦特數、伏特數、加熱組件護套及外部隔熱罩 (若有) 之材料、固定類型、出線端之類型及位置、感溫線孔及斷流器 (若有)、雙片式之瓦特數及伏特數 (各半)、數量。重要事項：若有感溫線孔及剖面，請提供尺寸草圖。

Specify - Inner Diameter, Width, Watts, Volts, Sheathing Material of Heating Element & Outer Insulation Cover (If any), Type of Clamping, Type of terminal & location, Size & Position of thermocouple holes & cut outs (If any), Wattage and voltage on 2 piece (Per half), Quantity. IMP: In case of thermocouple holes & cutouts, please provide dimensional sketch.

## 出線端 Options



## 固定 Clampings



## 選配 Terminals

### 雙套罩隔熱片 Double Jacket Insulation



另加 1/2" 的隔熱片，裝於有彈性的 SS 外殼中，可將護套的溫度降低至安全的程度。  
限制：最小 ID.：2 1/2"，最小寬度：3"

An additional 1/2" of thermal insulation encased in a separate flexible SS casing reduces sheath temperatures to a safe level.

Limitations: Min. I.D.: 2 1/2", Min. Width: 3"

### 鋼質出線端盒結構

#### Steel Terminal Box Construction



鋼質螺絲出線端與可產生最大安培承載量之實心鎳棒

Steel screw terminals connected to solid nickel pins designed to provide maximum amperage carrying capacity.

### 內部金屬護套

#### Inner Metal Sheath Casing



為避免組件污染並使熱能均勻轉移至滾筒，可在必要情況下提供金屬護套。

To avoid contamination with the element & also provide even heat transfer on to the cylinders, a specially designed metal sheath casing can be provided if required.

## 如何安裝 How to install

空氣間隙 AIR GAP

電熱片 HEATER

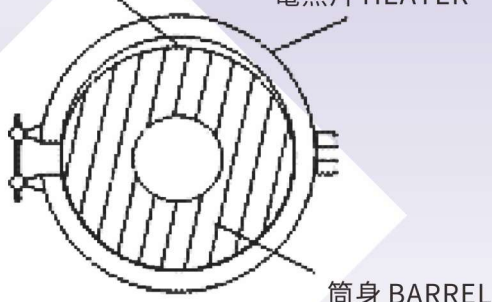

錯誤 WRONG

沒有空氣間隙 NO AIR GAP

電熱片 HEATER

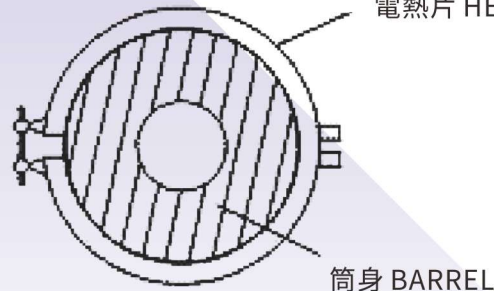

正確 CORRECT

筒身 BARREL

筒身 BARREL



# 鑄黃銅電熱片 Coil Heaters Cast in Brass

## 產品介紹 Introduction

正如名稱所顯示，這是具有不銹鋼管外殼的鑄銅線圈電熱片。它具有內建感溫線這項額外的特點，用途類似於線圈電熱片，例如熱澆道噴嘴、壓鑄噴嘴、延長管等，但具有某些特點優於線圈電熱片。

As the name indicates, this is a Coil Heater Cast in Brass having an outer casing of stainless steel tube. Available with an added feature of built in thermocouple, its applications are similar to coil heaters, such as Hot Runner Nozzles, Pressure Die Cast Nozzles, Tube Extrusion etc. ... but have some advantages over the Coil Heaters.

## 優點 The Advantages

- |   |  |
|---|--|
| <ol style="list-style-type: none"><li>1. 高度非腐蝕性</li><li>2. 因接觸面積較多，可達最大熱能轉移</li><li>3. 均勻的溫度分佈</li><li>4. 可精確安裝於熱澆道噴嘴上</li><li>5. 較高的瓦特密度</li><li>6. SS 外殼可做為隔熱片</li><li>7. 堅固的鑄造體可於外漏時抵擋壓力並避免線圈脫離</li></ol> <ul style="list-style-type: none"><li>● 電熱片具有非常特別的應用，可以客制化</li><li>● 電熱片的內徑經過研磨處理，具有 0.02 mm 的誤差容許範圍</li></ul> | <ol style="list-style-type: none"><li>1. Highly non corrosive</li><li>2. Maximum heat transfer due to more contact area</li><li>3. Even temperature profile</li><li>4. Precision fit on Hot Runner Nozzles</li><li>5. Higher watt density</li><li>6. SS casing acts as a heat insulator</li><li>7. Robust cast body can withstand pressure during leakages &amp; avoids de-coiling</li></ol> <ul style="list-style-type: none"><li>● As these heaters have very specific applications they are made as per customers requirement</li><li>● Inner diameter of these heaters are ground finished and can be provided with a tolerance of 0.02 mm</li></ul> |
|---|--|

## 最小壁厚度 Minimum Wall Thickness

無感溫線之機件：4 mm	Units without Thermocouples: 4 mm
有內建感溫線之機件：5 mm	Units with Built-in Thermocouples: 5 mm
有礦物隔熱感溫線之機件：6 mm	Units with Mineral Insulated Thermocouples: 6 mm
冷卻區	Cold zone:
最小 35 mm + 轉接器 35 mm = 總共 70 mm	Minimum 35 mm + Adapter 35 mm = Total 70 mm
內徑及長度	Inner Diameter & Length Dimensions:
10 mm 至 15 mm 最大長度 - 60 mm	10 mm to 15 mm Maximum Length - 60 mm
16 mm 至 19 mm 最大長度 - 100 mm	16 mm to 19 mm Maximum Length - 100 mm
20 mm 至 25 mm 最大長度 - 160 mm	20 mm to 25 mm Maximum Length - 160 mm

## 誤差容許範圍 Tolerance

內徑：-0.02 至 0.05	Inner Diameter: -0.02 to 0.05
長度：± 1 mm	Length: ± 1 mm
瓦特：± 10%	Watts: ± 10%

## 技術資料 Technical Data

護套材料：SS304  
 線圈護套材料：SS304  
 隔熱材料：高純度氧化鎂  
 加熱組件：NiCr 80 : 20  
 感溫線：「J」型 (Fe K), 「K」型 (Cr Al)  
 接地或未接地  
 連接線：PTFE 鍍鎳線  
 隔熱電阻 (冷) : > 5MW  
 電流外漏 : < 0.5 mA  
 最大操作溫度 : 450°C  
 轉接器溫度 : 最高 150°C

Outer Sheath material: SS304  
 Coil Heater Sheath material: SS304  
 Insulation material: High purity Magnesium Oxide  
 Heating element: NiCr 80 : 20  
 Thermocouple: 「J」 type (Fe K), 「K」 type (Cr Al)  
 grounded or ungrounded  
 Connection Wires: PTFE coated Nickel wires  
 H. V Testing: 800 V between sheath and resistance wire  
 500 V between T/C and resistance wire  
 Insulation Resistance: > 5MW  
 Current Leakage : < 0.5mA  
 Max. Operating Temperature : 450°C  
 Adapter Temperature : 150°C Max

## 庫存已有之標準尺寸 Standard Size Cast Heaters in Ready Stock

某些尺寸的電熱片庫存已有，可隨時出貨。這些電熱片具有 1000 mm 長的導線以金屬隔絕的「J」型感溫線。引線以矽玻璃纖維管保護。

These are some of the sizes we keep in ready stock for immediate delivery. These heaters have 1000 mm long lead wires and a Mineral insulated "J" type Thermocouple fitted along with it. The lead wires are protected with Silicon fibre glass sleeving.

PHP Part Number	OEM Part Number	ID mm	OD mm	長度 Length mm	引腳長度 Lead Length in mm	感溫線 Thermocouple	瓦特 Watts	伏特 Volts
K-22067	XRH-8270	22.6	38	67	1000	Yes	550	240
K-22080	XRH-8320	22.6		80	1000	Yes	550	240
K-22092	XRH-8370	22.6		92	1000	Yes	550	240
K-22110	XRH-8440	22.6		110	1000	Yes	550	240
K-22135	XRH-8540	22.6		135	1000	Yes	550	240
K-22160	XRH-8640	22.6		160	1000	Yes	550	240

## 下單時須提供技術資料 Technical Data Required while placing an order

- 內徑
- 外徑
- 瓦特數
- 伏特數
- 長度
- 導線長度
- 內建感溫線或外部感溫線
- Inner Diameter
- Outer Diameter
- Wattage
- Voltage
- Length
- Lead Length
- Built in Thermocouple or External Thermocouple

## 注意事項及安裝 Precautions & Installation

- 鑄黃銅電熱片因含氧化鎂，具吸濕性。若較長時間不使用，則終端將會潮濕。因此建議您於安裝前置於爐上以 100 ~ 120°C 加溫除濕，持續約 1 至 2 小時，或使用具有軟啟動功能的控制器。如此有助於蒸發任何內部的潮濕。
- 將鑄黃銅電熱片安裝至管嘴時，應當小心，將電熱片能安裝緊牢，使熱能均勻分佈。切勿以扭轉方式打開 ID，以免裝配不夠緊牢，造成電熱片過早失效。
- 由於每立方公分的高電量密度，電熱片需要精確的溫度控制器。PHP 建議使用品質優良的軟啟動熱澆道控制器。
- 導線末端 (非加熱) 若已彎曲，不應再度彎曲。應避開沿著導線路徑的鋒利邊緣。連結導線的部位應予以保護，以免接觸可燃燒的氣體及液體，以避免短路。
- 轉接器部位應維持 100°C 以下的溫度 (電熱片與導線之間的接合)
- 穩定之電壓供應可增加電熱片之壽命，並增加電流輸出。

- Cast Heaters are hygroscopic in nature due to Mgo contents. If kept unused for longer period, there is moisture deposition on the terminals. Therefore we recommend you to demoiseurise the heaters prior to installation by heating them at 100 ~ 120°C in an oven for approx. 1 to 2 hrs. or use controllers with soft start function. This will help evaporate any moisture present inside.
- While installing Cast Heaters on to the nozzle care should be taken that they should be tight fit for even heat ransfer. There should not be air gaps between the heater and the nozzle. Never open the ID of the heater by twisting as it will not fit tight which leads to premature heater failure.
- Due to high watt densities per cm/sq, Coil & Cast Heaters require precise temperature controllers. PHP strongly recommends to use good quality soft start Hot Runner controllers.
- Lead ends (Non Heating) once bent should not be rebent/de-coiled. This could lead to breakage. Sharp edges along the lead wire path should be avoided. Connection lead areas should be protected from cumbustable gases & liquid to avoid short-circuits.
- Adapter area should be kept under 150°C. (Junction between Heater & Lead wires)
- Stabilized Voltage supply increases the life of the heater as well as increases the wattage output.

# 電熱線圈 Coil Heaters

## 產品介紹 Introduction

電熱線圈係依先進的電熱工程原理，其結構與高瓦特密度插槽電熱片類似，也稱為高性能管狀電熱片或線型電熱片。

這些電熱片的基本結構是由密實的氧化鎂、高溫電阻線及不銹鋼管構成，無論有無內建的感溫線，均可建構。

它們通常是在加熱空間有限的情況下安裝，且普遍用於熱澆道噴嘴、歧管、鍛造噴嘴、包裝機器等等。

Coil heaters are an advance concept of thermal engineering which has a construction similar to high watt density cartridge heaters.

These heaters are also known as high performance tubular heaters or cable heaters. The basic construction of these heaters consist of compacted MgO, high temperature resistance wire and stainless steel tube.

These heaters can be constructed with or without built in thermocouples. They are usually installed where space available for heating is limited and are widely used on hot runner nozzles, and manifolds, die cast nozzles, packaging machines Etc.

## 可用之標準橫斷面 Standard Cross Sections Available

圓形 Round :  $\varnothing 3.3 \text{ mm}$   $\varnothing 3.8 \text{ mm}$

方形 Square :  $\sphericalangle 3.3 \text{ mm} \times 3.3 \text{ mm}$

扁平 Flat :  $\sphericalangle 2.2 \times 3.8$   $\sphericalangle 2.5 \times 4.3$

$\sphericalangle 2.7 \times 4.1$   $\sphericalangle 4 \times 6.4$

所有尺寸之誤差範圍  $\pm 0.1 \text{ mm}$

Tolerance on all dimensions  $\pm 0.1 \text{ mm}$

## 不同類型之出線端出口 Different Types of Termination Exits

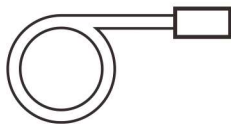

切線型 Tangential

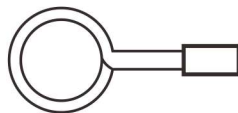

放射型 Radial



軸心型 Axial

## 尺寸資料 Dimensional Data

尺寸 Size	3.3	3.83	3.3×3.3	2.2×3.8	2.5×4.3	2.7×4.1	4×6.4
橫斷面 Cross Section							
冷區 Cold Zone	3.3	3.3	3.3	3.3	3.3	3.3	3.3
轉接器直徑 Adapter Diameter	7.5	7.5	7.5	7.5	7.5	7.5	7.5
轉接器長度 Adapter Length	32	32	32	32	32	32	32
線圈直徑 Crimp Diameter	9.5	9.5	9.5	9.5	9.5	9.5	9.5
最大長度 Maximum Length	2000	2000	2000	2000	2000	2000	2000
最大電流 Maximum Current	5 A	5 A	5 A	5 A	5 A	5 A	5 A
最大直徑 Maximum Diameter	8	8	8	8	8	8	8

## 技術資料 Technical Data

圓護套材料：SS304 及 SS316L  
隔熱材料：高純度氧化鎂  
電熱組件：鎳鉻 80：20  
感溫線：「J」型 (Fe K), 「K」型 (Cr Al)  
          接地或未接地  
連接線：PTFE 膜之鎳線  
電壓範圍：24 至 250 伏特  
功率：視用途而定  
功率誤差：± 10%  
H.V.測試：800 V (曲型電熱片)  
          500 V 介於 T/C 及電熱組件之間  
隔熱電阻：> 5 M  
電流外漏：< 0.5 mA  
護套溫度：最高 750°C  
轉接器溫度：最高 150°C  
長度誤差：加熱長度 ± 2%  
未加熱長：底端 5 ~ 10 mm，轉接器末端 50 mm  
          可應要求提供更長之長度。

Sheath material: SS304 and SS316L  
Insulation material: High purity MgO  
Heating element: NiCr 80 : 20  
Thermocouple: 「J」 type (Fe K), 「K」 type (Cr Al)  
          grounded or ungrounded  
Connection Wires: Stranded Nickel wires with PTFE coating  
Voltage Range: 24 to 250 volts  
Power Rating: Depending upon application  
Power Tolerance: ± 10%  
H. V Testing: 800 V (Bent heater)  
          500 V between T/C and resistance wire  
Insulation Resistance: > 5 M  
(Cold)  
Current Leakage : < 0.5mA  
Sheath Temperature: 750°C max  
Adapter Temperature: 150°C max  
Length Tolerance: Heated length ± 2%  
Unheated Length: 5 ~ 10 mm on bottom end, 50 mm  
at the adapter end. Larger lengths available on request.

## 不同種類的保護管 Different Types of Protection Hose

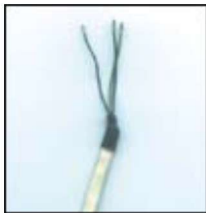

矽膜玻璃纖維管  
Silicone Coated  
Fibreglass Sleeve

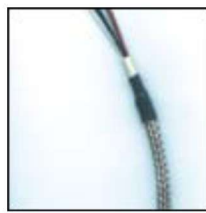

穗形套管  
Wire Braid Hose



不銹鋼彈性管  
Stainless Steel Flexible Conduit

## 注意事項及安裝 Precautions & Installation

1. 電熱線圈因含氧化鎂，具吸濕性。若較長時間不使用，則終端將會潮濕。因此建議您於安裝前置於爐上以 100 ~ 120°C 加溫除濕，持續約 1 至 2 小時，或使用具有軟啟動功能的控制器。如此有助於蒸發任何內部的潮濕。
2. 將電熱線圈安裝至管嘴時，應當小心，將電熱片能安裝緊牢，使熱能均勻分佈。切勿以扭轉方式打開 ID，以免裝配不夠緊牢，造成電熱片過早失效。
3. 由於每立方公分的高電量密度，電熱片需要精確的溫度控制器。PHP 建議使用品質優良的軟啟動熱澆道控制器。
4. 導線末端 (非加熱) 若已彎曲，不應再度彎曲。應避開沿著導線路徑的鋒利邊緣。連結導線的部位應予以保護，以免接觸可燃燒的氣體及液體，以避免短路。
5. 轉接器部位應維持 100°C 以下的溫度 (電熱片與導線之間的接合)
6. 穩定之電壓供應可增加電熱片之壽命，並增加電流輸出。

1. Coil Heaters are hygroscopic in nature due to MgO contents. If kept unused for longer period, there is moisture deposition on the terminals. Therefore we recommend you to demoise the heaters prior to installation by heating them at 100-120 Degree Centigrade in an oven for approximately 1 to 2 hours or use controllers with soft start function. This will help will help evaporate any moisture present inside.
2. While installing Coil Heaters on to the nozzle care should be taken that they should be tight fit for even heat transfer. There should not be air gaps between the heater and the nozzle. Never open the ID of the heater by twisting as it will not fit tight which leads to premature heater failure.
3. Due to high watt densities per cm/sq, Coil & Cast Heaters require precise temperature controllers. PHP strongly recommends to use good quality soft start Hot Runner controllers.
4. Lead ends (Non Heating) once bent should not be rebent/de-coiled. This could lead to breakage. Sharp edges along the lead wire path should be avoided. Connection lead areas should be protected from combustible gases & liquid to avoid short-circuits.
5. Adapter area should be kept under 150 Degree Centigrade. (Junction between Heater & Lead wires)
6. Stabilized Voltage supply increases the life of the heater as well as increases the wattage output.

## 庫存之電熱線圈 Ready Stock Coil Heaters

具有內建感溫線的多種電熱線圈(直線長度)已備有庫存，以便及時提供顧客所需。由於這些電熱線圈屬於直線長度且處於退火狀態，因此可應要求做成線圈且費用低廉。

注意：電熱片一旦彎曲或做成線圈形狀，不宜解除線圈形狀或將其彎曲

A wide range of Coil Heaters with built in Thermocouple are stocked in straight length with an intention to save our customers in the hour of need. As these heaters are in straight length and annealed condition they can be coiled as per requested dimension at a very nominal cost and dispatched within 48 hrs.

Caution: Once a heater is bent or coiled it is not advised to de-coil or re-bend the same.

## 技術資料 Technical Data

護套材料：SS304

橫斷面：2.5 × 4.3 (扁平)

感溫線：「J」型 (Fe K)

T/C 位置：感應點距離電熱片尖端  
5 mm 且未與護套接觸。

導線長度：1000 mm

導線連接：黑色 PFTE 導線 - 電源  
白色 PFTE 導線 - (+)正電  
紅色 PFTE 導線 - (-)負電  
綠色 PFTE 導線 - 接地

導線保護：可融入三種選配中的任一種

- 1) 矽膜玻璃纖維管
- 2) 穗形套管
- 3) 不銹鋼彈性管

Sheath material: SS304

Cross Section: 2.5 × 4.3 (Flat)

Thermocouple: "J" type (Fe K)

T/C Location: Sensing point is 5 mm away from the tip of the heater and is not in contact with the sheath

Lead Length: 1000 mm

Lead Connection: Black Color PFTE Leads-Power Supply  
White Color PFTE Leads - (+) positive  
Red Color PFTE Leads - (-) negative  
Green Color PFTE Leads- Ground (Earth)

Lead Protection: Any of the three available options can be incorporated:

- 1) Silicon Coated Fibreglass Sleeve
- 2) Wire Braid
- 3) Stainless Steel Flexible Conduit

瓦特 Watts	加熱長度 Heated Length	冷卻長度 Cold Length	電壓數 Volts	「J」型感溫線 "J" type Thermocouple
250	280 mm	50	230	Yes
330	400 mm	50	230	Yes
400	510 mm	50	230	Yes
470	600 mm	50	230	Yes
550	720 mm	50	230	Yes
650	840 mm	50	230	Yes
750	1020 mm	50	230	Yes
850	1150 mm	50	230	Yes
1000	1400 mm	50	230	Yes
1100	1650 mm	50	230	Yes
1200	1800 mm	50	230	Yes

電熱片與噴嘴之間之接觸面積 Contact Area Between the Heater & Nozzle																						
100- 50%											100- 45%				100- 40%							
有庫存型號的瓦特數 Available Watts from Ready Stock																						
250		330		400		470		550		650		750		850		1000		1100		1200		
100%	50%	100%	50%	100%	50%	100%	50%	100%	50%	100%	50%	100%	45%	100%	45%	100%	40%	100%	40%	100%	40%	
直徑 Diameter	以下所有尺寸均為公厘 All Dimension mentioned below are in mm																					
12 (1/2")	32	63	43	86	55	110	65	125	75	150												
16 (5/8")	26	55	35	70	45	90	50	100	60	120	70	140										
18	24	50	32	65	40	80	47	95	55	110	65	130	77	175								
19 (3/4")	23	47	31	62	39	77	45	90	53	105	63	121	73	165	82	185						
20	22	45	30	60	37	75	43	86	51	101	58	117	70	157	78	175	94	235				
22 (7/8")	21	42	28	56	35	70	40	80	47	94	54	120	65	145	72	162	87	217	101	252		
25 (1")	19	38	25	50	31	62	36	72	42	84	48	97	58	130	65	145	78	195	91	226	99	245
27	18	36	24	48	30	60	34	68	40	80	46	92	55	123	61	138	74	184	86	215	93	233
30	17	34	22	45	27	55	31	63	37	73	42	84	50	113	56	126	67	168	78	196	85	212
32 (1.25")	16	32	21	42	26	52	29	59	35	70	39	79	47	105	52	118	63	157	73	183	80	199
35	15	30	20	40	24	48	28	55	32	65	37	74	44	99	49	110	59	147	69	171	75	186
38 (1.5")	14	28	19	38	23	45	26	52	30	60	34	69	41	92	46	102	55	136	64	159	69	172

以上所有電熱片均為 230 伏特  
 100% = 緊密捲曲之長度 (未延伸)  
 50%、45%、40% = 建議之可延伸長度  
 誤差 = 長度 +/- 1 mm，內徑 -0.2 mm 至 -0.5 mm，  
 瓦特 +/- 10%  
 以上所有電熱片具有 2.5 mm × 4.3 mm 之橫斷面

Above mentioned heaters are designed at 230 volts  
 100% = Closely wound length (Unstretched)  
 50%, 45%, 40% = Recommended Stretchable Length  
 Tolerance = Length +/- 1 mm, Inner Diameter -0.2 mm  
 to - 0.5 mm, Watts +/- 10%  
 All the above heaters have a cross section of  
 2.5 mm × 4.3 mm

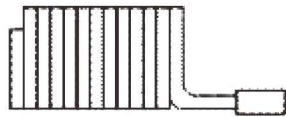

緊密捲曲 Close Wound



延伸 Stretched

下單時須提供技術資料 Technical Data Required while placing an order

- 內徑
- 線圈長度
- 橫斷面
- 導線長度
- 瓦特
- 導線出口 (出線端)
- 伏特
- 感溫線，若需要「J」型或「K」型
- Inner Diameter
- Coil Length
- Cross Section
- Lead Length
- Wattage
- Lead Exit (Termination)
- Voltage
- Thermocouple if required "J" or "K"

# 構形管狀電熱片 Formed Tubular Heaters

## 產品介紹 Introduction

構形管狀電熱片以不銹鋼供應，配有直徑 6.80 mm、8.00 mm 和 10.70 mm 的微形護套。

標準的組件具有螺紋的出線端，其冷卻橫斷面最小約為 40 mm，螺旋纏繞的電熱線係由耐高溫的 NiCr 合金製成，隔熱材料是由氧化鎂構成，由於電熱片係為鍛造，即使護套溫度高，也有良好的絕緣及高熱能轉移功能，為防止電熱潮濕，將連接末端以密封材料密封。

構形組件之製造必須有正確的尺寸圖，其中顯示所有中心距離、半徑範圍及角度。請在下單時提供此圖。

Formed Tubular Heaters can be supplied in either Stainless Steel or Incoloy with nominal sheath diameter of 6.80 mm, 8.00 mm and 10.70 mm. Standard elements have a threaded terminal post which gives a cold section of approx 40 mm minimum.

The helical wound heating wire is made of a high temperature resistant NiCr alloy. And the insulation consists of superior grade of magnesium oxide (MgO). As the heaters are swaged, even at high sheath temperature they have excellent electrical insulation and a high heat transfer. To prevent the heater from moisture the connection ends are sealed with sealing components.

For manufacturing formed elements it is necessary to have an accurate dimensional sketch showing all the center distances, radius and degrees, thus they need to be provided while placing the order.

## 技術資料 Technical Data

	Ø0.68 mm	Ø8.00 mm	Ø10.70 mm
長度 Length	300-1000 mm	300-3000 mm	300-3000 mm
最大電流 Maximum Current	8 A	15 A	15 A
名義電壓 Nominal Voltage	< 230 V	< 400 V	< 400 V
瓦特數 Wattage	± 10%	± 10%	± 10%
絕緣 (百萬歐姆) Insulation MW	5 ~ 100	5 ~ 100	5 ~ 100
最大未加熱 Minimum Unheated	35 mm	35 mm	50 mm
終端針棒 Terminal Pins	M3 × .50 mm	M3 × .50 mm M4 × .70 mm	M4 × .70 mm

長度誤差 Length Tolerances: ± 2%

直徑誤差 Diameter Tolerance: ± 0.10 mm

在設計構形管狀電熱片時，  
此事實應陳述於訂單中  
Ø6.8 之最小彎曲滾筒為 18 mm，  
Ø8 mm 為 24 mm，Ø10.7 mm 為 32 mm

During designing the formed Tubular Heaters this fact should be stated in the order.  
The minimum bending roller for Ø6.8 is 18 mm, for Ø8 mm is 24 mm and for Ø10.7 mm is 32 mm.

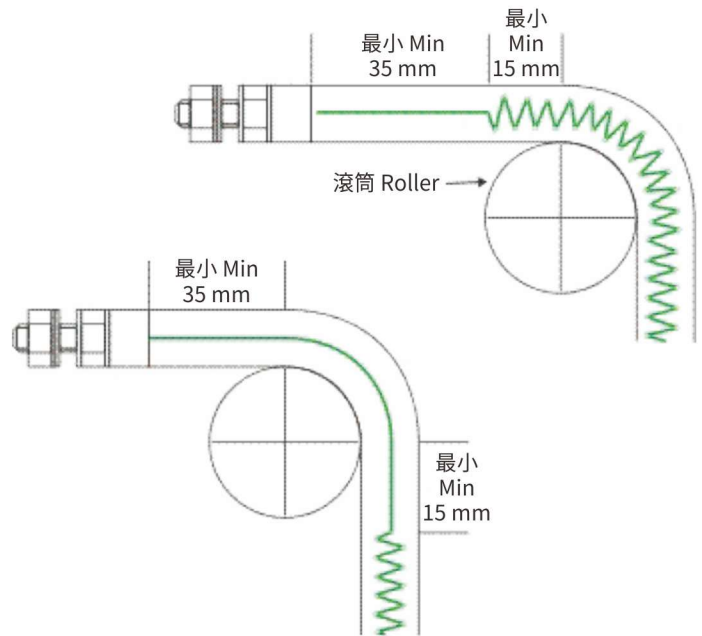
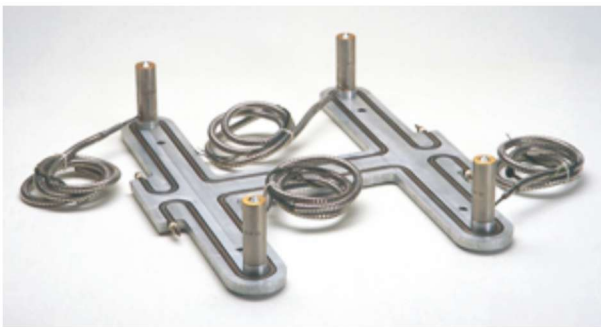

歧管中之構形管狀電熱片組合  
Formed tubular heater set in a manifold.

## 注意事項及安裝 Precautions & Installation

1. 配線不正確或鬆動的接點會導致火花，造成失火或電熱片失效。  
請妥善保護所有電力接點，以免造成危險。
2. 使用電壓穩定器及斷路器可確保電熱片電壓供給順暢，延長壽命。
3. 請確保連接盒在技術上之設計可承受電力負載以及移動所造成的震盪及搖晃。  
適當的連結導線 (隔熱) - 承受所需電流負載-也可降低電熱片失效的風險。
4. 確保終端均妥善隔絕及保護，因為很容易吸收水份。可燃性氣體及蒸氣也會造成碳堆積於終端，使電熱片失效。
5. 灑落於終端之原料 (聚合物) 以及滲透至捲片之污染物也會造成電熱片失效。安裝前，滾筒之表面應予以清潔，且應清除所有有可能在高溫下液化並滲入捲片且碳化及具有傳導性的污染物。最小量的污染可能造成電力短路並造成電熱片短路。
6. 若為浸入式電熱片，請定期清潔。將有助於延長電熱片的壽命，並在較短時間內達到最佳溫度，因此能夠省電。
7. 過熱會使電熱片超之運作超過最大負載量，成為毀壞整個加熱區、溫度感應器及控制器缺損的原因。  
瓦特數的計算應盡量接近操作瓦特數，以將開閉循環減至最少。若電熱片無內建的熱電耦，則應確保感應器 (外部感溫線) 的尖端清潔且沒有任何污染，並應檢查其是否能對溫度變化有良好反應。
8. 使用低於標準的材料及製造上的缺失，也都是電熱片失效的原因。

1. Incorrect wiring and loose contacts leads to sparks resulting in fire or heater failure. Keep all electrical connections properly protected to avoid electrical hazards to machine operators.
2. Use of voltage stabilizers and Circuit breakers ensures smooth supply of voltage to heaters resulting a longer life.
3. Ensure that the terminal junction is technically engineered to withstand the ampere load as well as the shocks and jerks due to movements. Appropriate connection leads (Insulated) to withstand the required ampere load also reduce the risk of heater failure.
4. Ensure that the terminals are well insulated and protected since the heater terminals are prone to attracting moisture. Combustible gasses & vapours also leads to deposits of carbon on the terminals.
5. Raw materials (Polymers) spilling on the terminals & contamination (Oil/Grease) penetrating the heaters. Prior to installation, the area must be cleaned & should be free of all contamination that might liquefy under heat and penetrate into the heaters hereby carbonizes & becomes conductive. The smallest amount of contamination can cause electrical shorts and result to heater failure.
6. In case of immersion heaters we recommend you to clean (Descale) the heaters on regular intervals. This helps increase life of heaters as well as optimum achievement of temperature in a shorter period, thereby saves power.
7. Overheating that leads the heater to operate beyond the maximum capacity can be a cause for destroying an entire heating zone, defect temperature sensors and controllers. The wattage should be calculated as close as possible to operating wattage to minimize on-off cycle resulting to power saving. Ensure that the thermocouples are clean and free from any contamination and should be checked for good response to temperature changes.
8. Use of substandard raw materials & manufacturing defects is also one of the common cause of heater failure.



# 高瓦特密度長筒電熱片

## High Watt Density Cartridge Heaters

### 產品介紹 Introduction

PHP 的高瓦特密度長筒電熱片係根據多年的經驗設計及製造，因此性能及壽命優於其他長筒電熱片。加熱導體 NiCr 80 : 20 均勻捲曲於支撐的核心，此核心位於 SS304 管的中央，且內部空間填充了特選的高純度氧化鎂。然後此組件被高度壓縮，將核心、粉劑及導體轉換為單一的個體。電熱片的底端以碟型墊片焊接，以防止污染。

PHP's High Watt Density Cartridge Heaters are designed and manufactured out of experience of many years, thus the performance and life expectancy super seeds other cartridge heaters. Heating Conductor grade NiCr 80 : 20 is evenly wound over a supporting core which is centrally located in a SS304 tube and the inner space is filled with specially selected high purity magnesium oxide. This assembled unit is then highly compressed, converting the core, powder and conductor into a homogenous mass. The bottom end of the heater is welded with a disc washer to prevent contamination. For manufacturing formed elements it is necessary to have an accurate dimensionalsketch showing all the center distances, radius and degrees, thus they need to be provided while placing the order.

### 下單時須提供技術資料 Technical Data Required while placing an order

外部護套材料：不銹鋼 304，焊接的末端碟型墊圈也是相同材質。最大操作溫度 750°C 護套可研磨，以容許精確度誤差

(僅限於具有捲曲之電熱片)

加熱導體：NiCr 80 : 20

功率：± 10%

電壓：12 至 440 瓦

外漏電流：< 5 mA

高電壓：800 V

表面負載：最高達 50 watt/cm<sup>2</sup>

導線屬性：

- A) 捲曲導線：30 mm 長之純鎳桿，以電線纏繞，可選擇 PFT 或玻璃纖維
- B) 鍛入式導線：從電熱片內部出線之玻璃纖維或 PFTE 導線

Outer Sheath material: Stainless Steel 304, welded end disc washer of same material. Maximum operating temperature 750°C. Sheath can be ground for precision tolerance (Only for heaters with crimped on leads)

Heating Conductor: NiCr 80 : 20

Power: ± 10%

Voltage: 12 to 440 volts

Leakage Current: < 5 mA

High Voltage: 800 V

Surface Loading: up to 50 watts/ cm<sup>2</sup>

Lead Orientation: A) Crimped on leads: 30 mm long annealed pure nickle rods crimped with wires of your choice PFTE or Fibreglass

B) Swaged in Leads: Flexible Fibre Glass or PFTE leads emerging from within the heater.

### 尺寸資料 Dimensional Data

直徑 Nominal Diameter	1/4"	6.5	5/16"	8	3/8"	10	1/2"	12.5	5/8"	16	3/4"	19
最小直徑 Minimum Diameter	.246	6.42	.309	7.92	.372	9.92	.496	12.42	.621	15.92	.746	18.92
最大直徑 Maximum Diameter	.249	6.48	.311	7.98	.374	9.98	.499	12.48	.624	15.98	.749	18.98
最小長度 Minimum Length	1 1/2"	38	1 1/2"	38	1 1/2"	38	2"	50	2"	50	3"	75
最大長度 Maximum Length	8"	200	8"	200	10"	250	18"	450	24"	600	24"	600
導線 Lead wires in mm <sup>2</sup>	.5	.5	.75	.75	.75	.75	1	1	1.5	1.5	2.5	2.5
最大安培 Maximum Amperes	4	4	6	6	6	6	8	8	12	12	18	18

上述以外之選配，請與本公司聯絡

For options other than mentioned above, please consult.

## 建議標準尺寸 Recommended Standard Sizes

直徑 Diameter	長度 Length	230 V 之建議瓦特數 Recommended Watts on 230 V			
(1/4" - 6.30 mm) or 6.50 mm	(1 1/2" - 38 mm) - 40 mm	100	125	160	175
	(2" - 52 mm) - 50 mm	100	160	200	
	(2 1/2" - 64 mm) - 60 mm	125	200	250	
	(3 1/4" mm - 83 mm) - 80 mm	125	180	280	350
	(4" - 102 mm) - 100 mm	160	220	350	
(5/16" - 7.90 mm) or 8.00 mm	(2" - 52 mm) - 50 mm	125	200	250	
	(2 1/2" - 64 mm) - 60 mm	100	140	220	280
	(3 1/4" mm - 83 mm) - 80 mm	160	200	315	400
	(4" - 102 mm) - 100 mm	180	280	400	
	(5 1/4" - 127 mm) - 130 mm	250	400		
(3/8" - 9.50 mm) or 10.00 mm	(2" - 52 mm) - 50 mm	100	160	250	315
	(2 1/2" - 64 mm) - 60 mm	125	200	315	400
	(3 1/4" mm - 83 mm) - 80 mm	160	250	400	500
	(4" - 102 mm) - 100 mm	220	350	560	700
	(5 1/4" - 127 mm) - 130 mm	315	500	800	
	(6 1/2" - 165 mm) - 160 mm	400	630		
(1/2" - 12.70 mm) or 12.50 mm	(2" - 52 mm) - 50 mm	100	200	315	400
	(2 1/2" - 64 mm) - 60 mm	125	200	315	400
	(3 1/4" mm - 83 mm) - 80 mm	200	315	500	630
	(4" - 102 mm) - 100 mm	250	400	630	800
	(5 1/4" - 127 mm) - 130 mm	400	630	1000	
	(6 1/2" - 165 mm) - 160 mm	500	800	1250	
	(8" - 203 mm) - 200 mm	630	900		
	(10" - 254 mm) - 250 mm	1000	1500		
(5/8" - 15.87 mm) or 16.00 mm	(2" - 52 mm) - 50 mm	160	250	400	500
	(2 1/2" - 64 mm) - 60 mm	160	250	400	500
	(3 1/4" mm - 83 mm) - 80 mm	280	400	630	800
	(4" - 102 mm) - 100 mm	350	500	800	1000
	(5 1/4" - 127 mm) - 130 mm	500	700	1100	1400
	(6 1/2" - 165 mm) - 160 mm	630	900	1600	
	(8" - 203 mm) - 200 mm	800	1250	2000	
	(10" - 254 mm) - 250 mm	1000	1500		
	(12" - 305 mm) - 300 mm	1250	1800		
	(3/4" - 19.00 mm) or 20.00 mm	(3 1/4" mm - 83 mm) - 80 mm	350	500	800
(4" - 102 mm) - 100 mm		450	630	1000	1400
(5 1/4" - 127 mm) - 130 mm		630	900	1400	1800
(6 1/2" - 165 mm) - 160 mm		800	1100	1800	2200
(8" - 203 mm) - 200 mm		1000	1600	2500	
(10" - 254 mm) - 250 mm		1250	2000		
(12" - 305 mm) - 300 mm		1600	2200		

## 注意事項及安裝 Precautions & Installation

- 長筒組件係以特殊的管子製成，其尺寸略小數千分之一，以確保能自由安裝。為安裝長筒電熱片，請將洞孔鑽至適當長度及長筒電熱片直徑 (3/8 英吋、1/2 英吋、5/8 英吋) +/-0.001 英吋誤差範圍之內，以確保適當的安裝。務必將鑽控、鍛造的洞孔上漆，以確保順暢、一致的金屬接觸，使熱能有效轉移。若有可能，應提供另一打穿的洞孔，以輔助長筒的移除。若瓦特數密度高達 150 W/In<sup>2</sup> 以上，我們建議壓下分開孔。安裝太鬆的組件熱能轉移不佳，且會因為護套的溫度太高而縮短壽命。應將它們以最低的誤差緊密安裝。
  - 安裝之前，洞孔必須加以清潔，且應無任何在高溫下會液化，並滲入電熱片因而碳化且具有傳導性的污染物。最小量的污染物可能造成電熱片失效。灑在終端上的原料 (聚合物) 及滲入電熱片的污染誤會造成電熱片失效。可燃的氣體及蒸氣也會導致碳累積至終端上，造成電熱片失效。
  - 物理或機械的損壞也可能造成電熱片失效，因為它會使電熱片組件受損。
  - 組件由於具有吸水性，若暴露或儲存於潮濕的地點或氣候當中，會發生吸水的情況。若長時間不使用，終端會累積水份，造成電熱片失效。因此建議您於安裝前置於爐上以 100 ~ 120°C 加溫除濕，持續約 1 至 2 小時，或使用具有軟啟動功能的控制器。
  - 過熱會造成電熱片超過最大負載，毀壞整個加熱點。瓦特數的計算應盡量接近操作瓦特數，以將開閉循環減至最少。若電熱片無內建的感溫線，則應確保感應器 (外部感溫線) 的尖端清潔且無任何汙染物，並檢查是否良好。有缺失的感應器及控制器也會導致電熱片失效。
  - 導線末端 (非加熱) 一旦彎曲，不應再彎曲，以免造成斷裂。連接的導線區域應加以保護，防止可燃氣體或液體，以免短路。
  - 穩定的電壓供應可延長電熱片壽命及電流輸出。
- install cartridge heaters, drill and ream holes to proper length and the nominal diameter +/- 0.001 inches maximum of the cartridge Heater (3/8 Inch, 1/2 Inch, 5/8 Inch etc.). A hold should be drilled & reamed to 1/2 Inch diameter +/- 0.001 Inch to insure a proper fit. Always finish ream, drilled or cast holes to ensure a smooth, uniform metal contact for efficient heat transfer. A knockout hole should be provided if possible to facilitate cartridge removal. For watt density over 150W/In<sup>2</sup> we recommend press fit split bores. Elements that fit too loosely will have poor heat transfer and shortens life due to excessively high sheath temperature. They should be tight fit with minimum tolerance in reamed holes.
  - Prior to installation, the holes must be cleaned & should be free of all contamination that might liquefy under heat and penetrate into the heater thereby carbonizes & becomes conductive. The smallest amount of contamination can cause electrical shorts and results in heater failure. Raw materials (Polymers) spillage on the terminals & contamination (Oil/Grease) penetrating into the heaters results in failure of heaters. Combustible gases & vapors also leads to deposits of carbon on the terminals resulting in failure of heaters.
  - Physical or mechanical damage can also result in failure of the heater as it can damage the element in the heater.
  - Due to hygroscopic in nature moisture absorption can occur when element is exposed or stored in damp or wet climate. If kept unused for longer period, there is moisture deposition on the terminals which results in heater failure. It is recommended to de-moisturize the heaters prior to installation by heating them at 100-120°C in an oven for approximately 1 to 2 hours or use controllers with soft start function.
  - Overheating that leads the heater to operate beyond the maximum capacity can be a cause for destroying an entire heating zone. The wattage should be calculated as close as possible to operating wattage to minimize on-off cycle resulting to power saving. In case of heaters without In-Built thermocouple ensure that the tips of the sensors (External thermocouples) are clean and free from any contamination and should be checked for good response to temperature changes. Defective temperature sensors and controllers also lead to heater failures.
  - Lead ends (Non Heating) once bent should not be re-bent. This could lead to breakage. Sharp edges along the lead wire path should be avoided. Connection lead areas should be protected from combustible gases & liquid to avoid short-circuits.
  - Stabilized Voltage supply increases the life of the heater as well as increases the wattage output.

# 雲母帶電熱片 Mica Band Heaters

## 產品介紹 Introduction

射出成型、中空成型、押出機、包裝工業、實驗室器材、製鞋工業、橡膠工業及各種其它塑膠處理機械。

Injection molding, Blow molding, Extruders, Packaging industry, Laboratory equipments, Shoe industry, Rubber industry and various other plastic processing machinery.

## 技術資料 Technical Data

1. PHP 雲母帶電熱片之供應，可分成有加裝或未加裝不同護套材質製成的外層隔熱護罩。這些材質包括 S. S、銅、MS 等，視用途而定提供物理強度、高排放性及良好傳導性的最佳組合，將滾筒零件加熱，護套溫度最高可達 400°C。
2. 為達到最大的連接表面並保護露出的出線端，將特製的鋼盒附加至電熱片，其中的出線端線將正極的接觸點與捲片相繫，提供最大的電力攜帶能力。
3. 特製的測量式鎳鉻電阻線經過適當設計，可達到最低的捲曲溫度，達到電熱片的最大壽命。此電阻線間隔均勻地纏繞於特別選擇的雲母帶上，提供均勻的熱能分佈，消除可能造成電熱片過早失效的熱點。
4. 特選等級及厚度的雲母可阻隔捲片，提供優良的熱傳導及電介質強度。
5. 這些電熱片可供應不同的出線端及固定型式。
6. 為使熱能流失降至最低，電熱片可根據顧客的規格量身訂做，將熱能節省之隔熱罩置於電熱器外部表面上。

1. PHP Mica Band heaters are available with or without outer heat saving insulation covers in various sheathing materials, viz., S. S, Brass, MS, depending upon applications which provides the best combination of physical strength, high emissivity & good thermal conductivity to heat cylindrical parts, good for sheath temperature up to 400°C
2. For maximum connecting surface and protect exposed terminals, a specially designed steel box is affixed on the heater, where the terminal wires are securely fastened to an assuming positive contact with the windings, providing max. amperage carrying capacity.
3. A specific gauge nickel-chrome resistance ribbon wire is properly engineered to achieve the lowest winding temperature possible, resulting in maximum heater life. The ribbon wire is evenly spaced wound on specially selected mica strip providing even heat distribution, thus eliminating hot spotting that can cause premature heater failure.
4. Specially selected mica grade & thickness is used to insulate windings providing excellent thermal conductivity & dielectric strength.
5. These heaters are available in various lead terminations & clamping variations. (See overleaf)
6. For minimum heat loss band heaters are also specially made as per customers specification with heat saving insulated cover on the outer surface of the heater.

## 下單時須提供技術資料 Technical Data Required while placing an order

護套材料：SS304 及銅

隔熱材料：雲母

熱能節省隔熱片：厚陶瓷纖維 (標準 1/8" 厚)

加熱組件：NiCr 60 : 16, NiCr 80 : 20

後出線端：< 750 W 5/32" × 3/4",  
> 750 W 3/16" × 3/4"

名義壁厚度：3/16" (無隔熱套)

連接線：玻璃纖維辮帶/金屬辮帶

電壓範圍：110 V ~ 440 V

表面負載：達 30 W/In<sup>2</sup> (視應用而定)

功率等級：視應用而定

功率誤差：± 10%

HV測試：加熱組件與套殼之間 1.5 KV

隔熱電阻 (冷)：< 20M Ohms

護套溫度：最高達 400°C (SS 護套)

Sheath material: SS304 and Brass

Insulation Material: I Mica

Heat Saving Insulation: Ceramic Fiber Thermal Insulation  
(Std. 1/8" thick)

Heating Elements: NiCr 60 : 16, NiCr 80 : 20

Post Terminals: < 750 W 5/32" × 3/4", > 750 W 3/16" × 3/4"

Nominal Wall Thickness: 3/16" (Without insulating cover)

Connection Wire: Fiber Glass Braided/Metal Braided  
(Std. 10" long)

Voltage Range: 110 V - 440 V

Surface Loading: Up to 30 W/In<sup>2</sup> (Depending upon application)

Power Rating: Depending upon application

Power Tolerance: ± 10%

HV Testing: 1.5 Kv between heating element and sheath

Insulation Resistance (Cold): < 20M Ohms

Sheath Temperature: Up to 400°C maximum (SS sheath)

## 限制 Limitations

最小內徑 Min. Inside Diameter	25 mm without mounting/thermocouple holes 25 mm 無托架/感溫線孔
最小寬度 Min. Width	35 mm with mounting/thermocouple holes 35 mm 具托架/感溫線孔
容許誤差 Tolerance Allowed	
直徑 Diameter	-2 mm
寬度 Width	± 2 mm
電阻 Resistance	± 10% , -5%
瓦特 Wattage	+5% , -10%
標準間隙 Std. gap	10 mm

## 名義未加熱面積 Nominal Unheated Area

單片結構 One piece construction : 1" × Width

雙片結構 Two piece construction : 2" × Width

洞孔及剪穿 Holes and Cutout : 尺寸 × 1/2" × Width

## 下單時須提供技術資料 Technical Data Required while placing an order

內徑、寬度、瓦特數、伏特數、加熱組件護套及外部隔熱罩 (若有) 之材料、固定之類型、出線端之類型及位置、感溫線孔及斷流器 (若有)、雙片式之瓦特數及伏特數 (各半)、數量。  
注意事項：若有感溫線孔及剖面，請提供尺寸草圖

Specify - Inner Diameter, Width, Watts, Volts, Sheathing Material of Heating Element & Outer Insulation Cover (If any), Type of Clamping, Type of terminal & location, Size & Position of thermocouple holes & cut outs (If any), Wattage and voltage on 2 piece (Each 1/2), Quantity, IMP: In case of thermocouple holes & cutouts, please provide dimensional sketch.

## 固定型式 Clampings



## 出線端 Terminals



## 感溫線孔/U型狹孔/剪裁孔 Thermocouple Holes/U Slots/Cutout



通常需要孔位，以留作感溫線探測器的空位或固定螺栓用。尺寸過大的間隙也有相同作用，以間隙的中心做為起點，標明洞孔或剪裁口之角度及尺寸。從洞孔至電熱器邊緣，至少需要 1/2"。若要洞孔或剪裁口處於精確位置，請提供詳細的圖。

Normally required for clearance of the thermocouple probes or holding bolts. Oversize gap can in many cases serve the same purpose, using the centre of the gap as a starting point, specify location in terms of degrees and size of the hole or cut-out. Minimum of 1/2" is required from the hole to the edge of the heater. For critical hole or cut-out locations, please provide detailed drawing.



註：請盡量避免不必要的感溫線孔位。請試者將這些孔位置於電熱片間隙，因為電熱片體上的孔位會使內部的配線複雜，造成加熱面積減少，且費用也會變得更多。

Note: As far as possible please avoid thermocouple holes. Try and locate them in the heater gap, since holes in the heater body complicates the internal wiring resulting in less heating area and also turns out to be more expensive.

## 雙片式結構 Two Piece Construction



可用於任何螺絲或導線出線端或固定變化。用於大型滾筒或電熱片無法涵蓋滾筒出線端時。雙片式的電熱片通常以瓦特數及電壓數之半數衡量。限制：最小 I.D. : 3" 最小寬度 : 1 1/2"

Available on any screw or lead termination or clamping variation. Used on large cylinders or where heaters cannot be slipped over end of cylinders. Two piece Band Heaters are normally rated at half total wattage and full line voltage. Limitations: Min. I.D. : 3" Min. Width: 1 1/2"

## 如何安裝 How to install

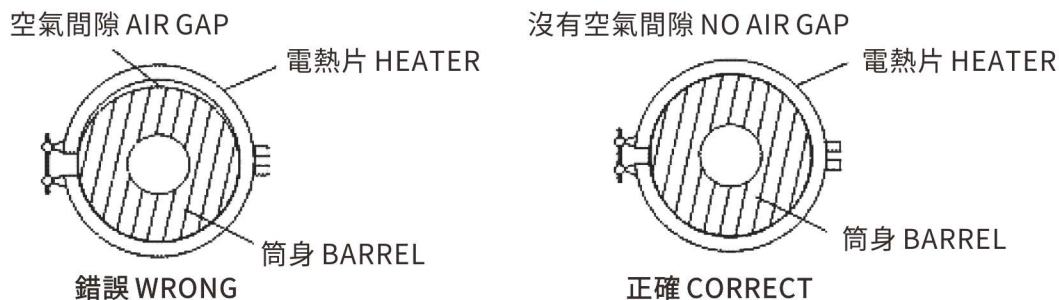

## 注意事項及安裝 Precautions & Installation

1. 配線不正確或鬆動的接點會導致火花，造成失火或電熱片失效。請妥善保護所有電力接點，以免造成危險。
  2. 使用電壓穩定器及斷路器可確保電熱片電壓供給順暢，延長壽命。
  3. 請確保連接盒在技術上之設計可承受電力負載以及移動所造成的震盪及搖晃。適當的連結導線 (隔熱) - 承受所需電流負載 - 也可降低電熱片失效的風險。
  4. 將電熱片不當安裝於滾筒上會造成熱點。片狀及帶狀的電熱器係用於接觸式的加熱，因此必須與被加熱之物體夾緊，這麼做在於電熱片溫度上升時，會從加熱表面擴大，造成空氣間隙，使熱能轉移不良。應小心將電熱片放正於加熱表面上。若為陶瓷電熱片，將外殼上緊至鋸齒邊緣堅硬且與滾筒咬合一致為止。勿過度上緊。
  5. 確保出線端妥善隔絕及保護，因為電熱片出線端容易吸收水份。可燃性氣體及蒸氣會造成碳堆積於出線端上。
  6. 灑落於出線端之原料 (聚合物) 以及滲透至捲片之污染物也會造成電熱片失效。安裝前，滾筒之表面應予以清潔，且應清除所有可能在高溫下液化並滲入捲片且炭化及具有傳導性的污染物。最小量的污染可能造成短路。
  7. 過熱會使電熱片超之運作超過最大負載量，使毀壞整個加熱區的原因。
  8. 有缺損的溫度感應器及控制器。選擇正確類型的電熱片，例如雲母隔熱電熱片，可用於 0 至 400°C 之溫度。瓦特數之計算應盡可能接近作業瓦特數，以將開閉的循環減至最少，以達成省電。請確保感應器 (感溫線) 的尖端之清潔且沒有任何汙染，且應檢查其是否能對溫度變化有良好反應。
1. Incorrect wiring and loose contacts leads to sparks resulting in fire or heater failure. Keep all electrical connections properly protected to avoid electrical hazards to machine operators.
  2. Use of voltage stabilizers and circuit breakers ensures smooth supply of voltage go heaters resulting a longer life.
  3. Ensure that the junction box is technically engineered to withstand the ampere load as well as the shocks and jerks due to movements. Appropriate connection leads (Insulated) to withstand the required ampere load also reduce the risk of heater failure.
  4. Improper installation of heaters on the barrel that leads to hot spots. Band & Strip heaters are designed for contact heating & therefore must be tightly clamped to the object to be heated. The reason for this is that, as the heater heats up, it expands away from the surface to be heated causing air gaps resulting to poor heat transfer. Care should be taken to see that the heaters are placed squarely against the surface to be heated. In case of ceramic band heaters, take up all the slack by tightening outer housing Two Piece Construction until the serrated edges are firm and get uniform in contact with the cylinder and do not over tighten.
  5. Ensure that the terminals are well insulated and protected since the heater terminals are prone to attracting moisture. Combustible gases & vapors also leads to deposits of carbon on the terminals resulting in failure of heaters.
  6. Raw materials (Polymers) spilling on the terminals & contamination (Oil/Grease) penetrating into the windings of the heaters. Prior to installation, the surface of the cylinder must be cleaned & should be free of all contamination that might liquefy under heat and penetrate into the windings thereby carbonizes & becomes conductive. The smallest amount of contamination can cause failure.
  7. Overheating that leads the heater to operate beyond the max capacity can be a cause for destroying an entire heating zone.
  8. Defective temperature sensors and controllers. Choose the correct type of heaters, ie. Mica Insulated Band Heaters for applications up to max 0 ~ 400°C. The wattage should be calculated as close as possible to operating wattage to minimize on-off cycle resulting to power saving. Ensure that the tips of the thermocouples are clean and free from any contamination.

# 授權經銷商 DISTRIBUTORS



長新科技股份有限公司  
ARICO TECHNOLOGY CO., LTD.

## 總公司【Headquarters】

☎ +886-2-2910-1266

☎ +886-2-2915-9434

✉ info@arico.com.tw

📍 231028 新北市新店區寶橋路 235 巷 1 弄 1 號 8 樓  
8F., No. 1, Alley 1, Lane 235, Baoqiao Rd.,

Xindian Dist., New Taipei City 231028, Taiwan

🌐 www.arico.com.tw/www.arico.tw



## 台北工廠【Taipei Factory】

☎ +886-2-2910-1077

☎ +886-2-2910-1056

## 台中分公司【Taichung Branch】

☎ +886-4-2291-7011

☎ +886-4-2292-4021

## 台南分公司【Tainan Branch】

☎ +886-6-253-9940

☎ +886-6-253-9945

## 華南總經銷

東莞亞洛克【Dongguan】

☎ +86-769-8390-2101~3

☎ +86-769-8398-8791

## 華東總經銷

上海瑞昂【Shanghai】

☎ +86-21-6111-5256~9

☎ +86-21-6227-0065

長新科技股份有限公司 保有權利於任何時間未經通知而修改或變更本手冊內容及型式，未經本公司同意，不得作任何形式的使用。

ARICO TECHNOLOGY CO., LTD. Reserves the right to make any kind of design or functional modification at any moment without prior notice. AT-B-CBH-1.0.5